

Model

- SM-100.3
- SM-100.5
- SM-250.5
- SM-250.5TL



1X

4X

4X

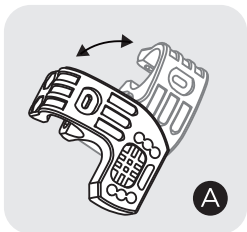
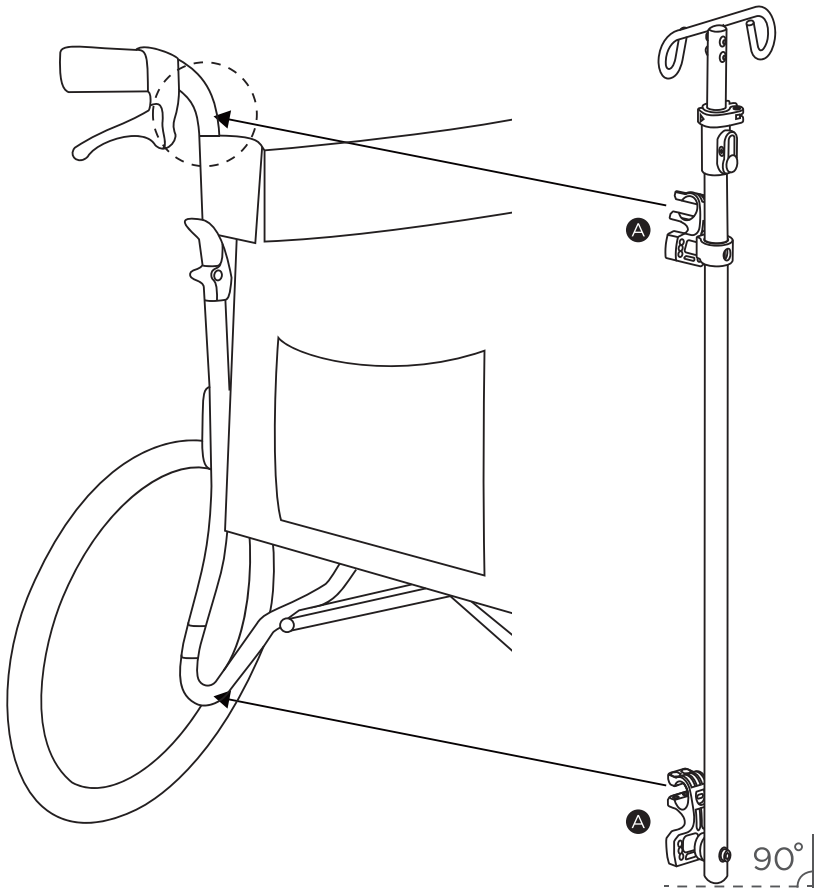

1-1

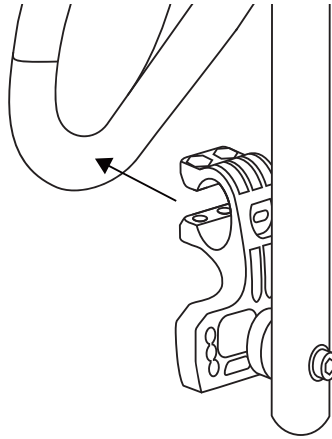

1-2

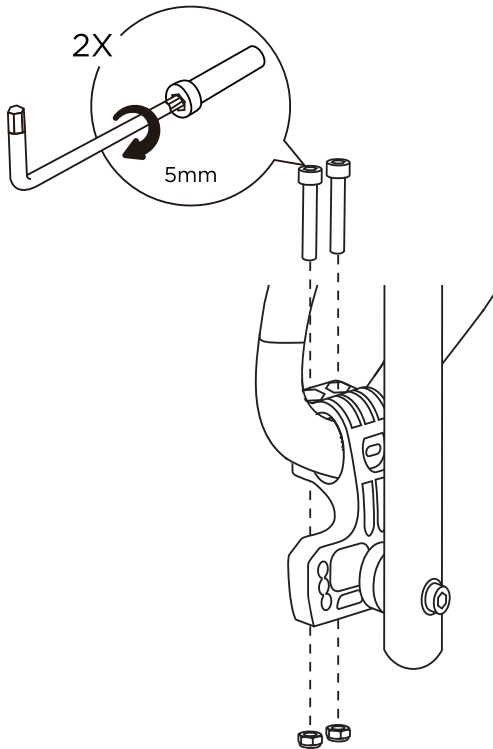

2-1

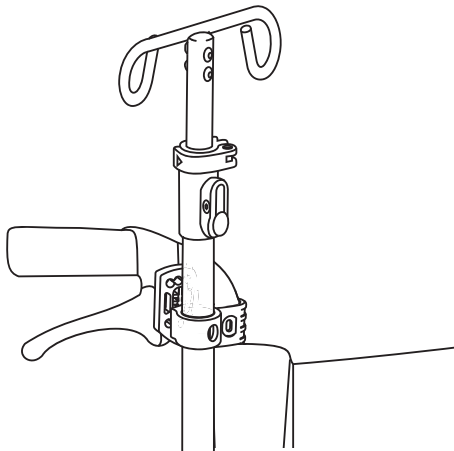
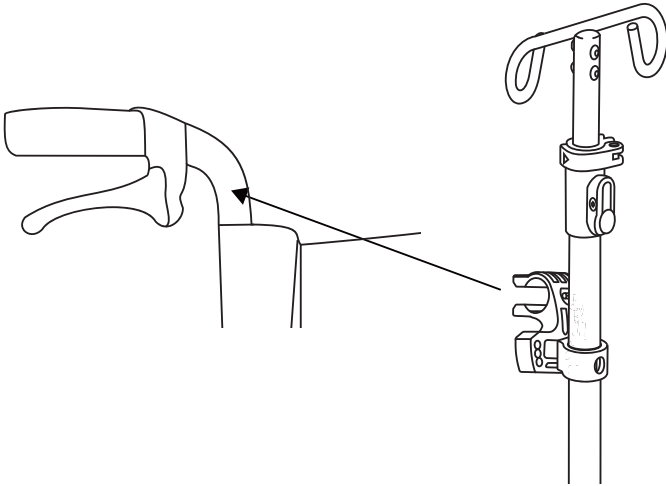

2-2

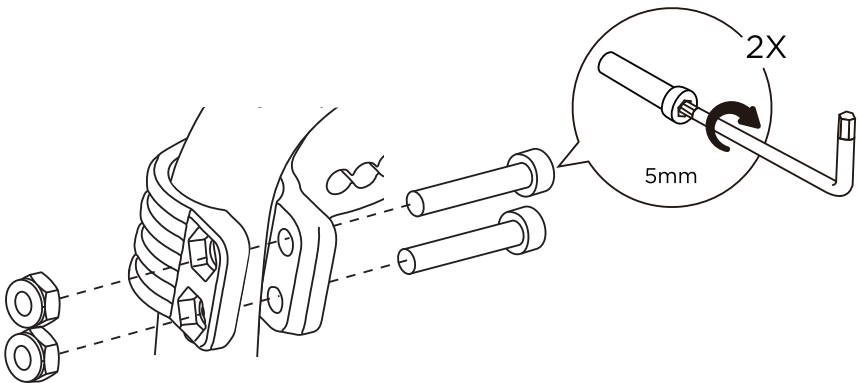
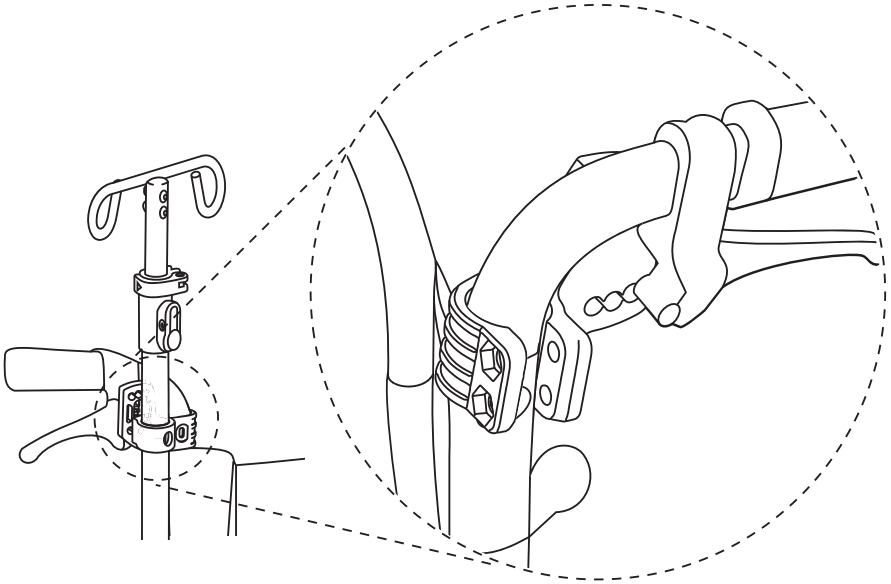

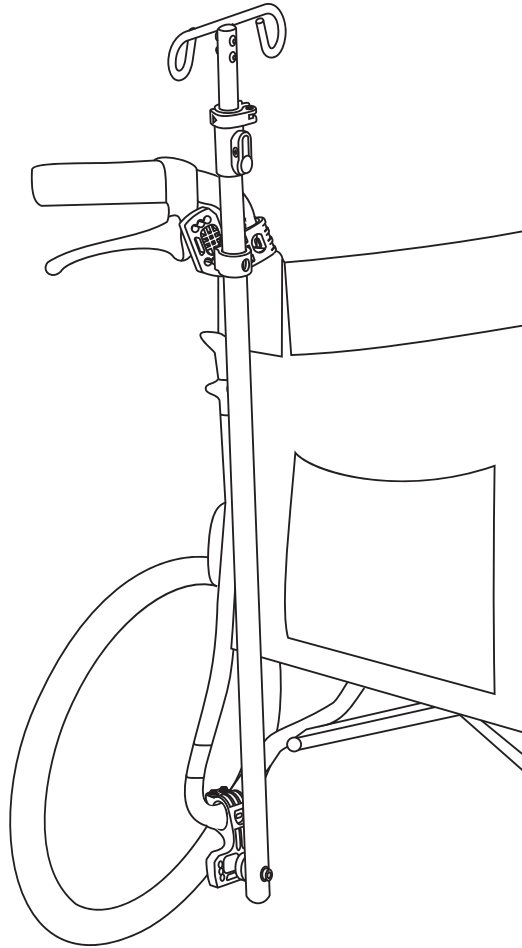

karma

A Better Wheelchair, A Better Fit

KARMA MEDICAL PRODUCTS CO., LTD.

www.karmamedical.com
T +886-5-206 6688

Email: globalsales@karma.com.tw
F +886-5-206 7788

CE ISO13485

110400001682 Rev.01 Feb.2026